

KONICA MINOLTA

AccurioLabel 230

**YOU WANT
PROFITABLE LABEL
PRODUCTION IN
SMALL BATCHES.
RETHINK LABEL PRINTING**

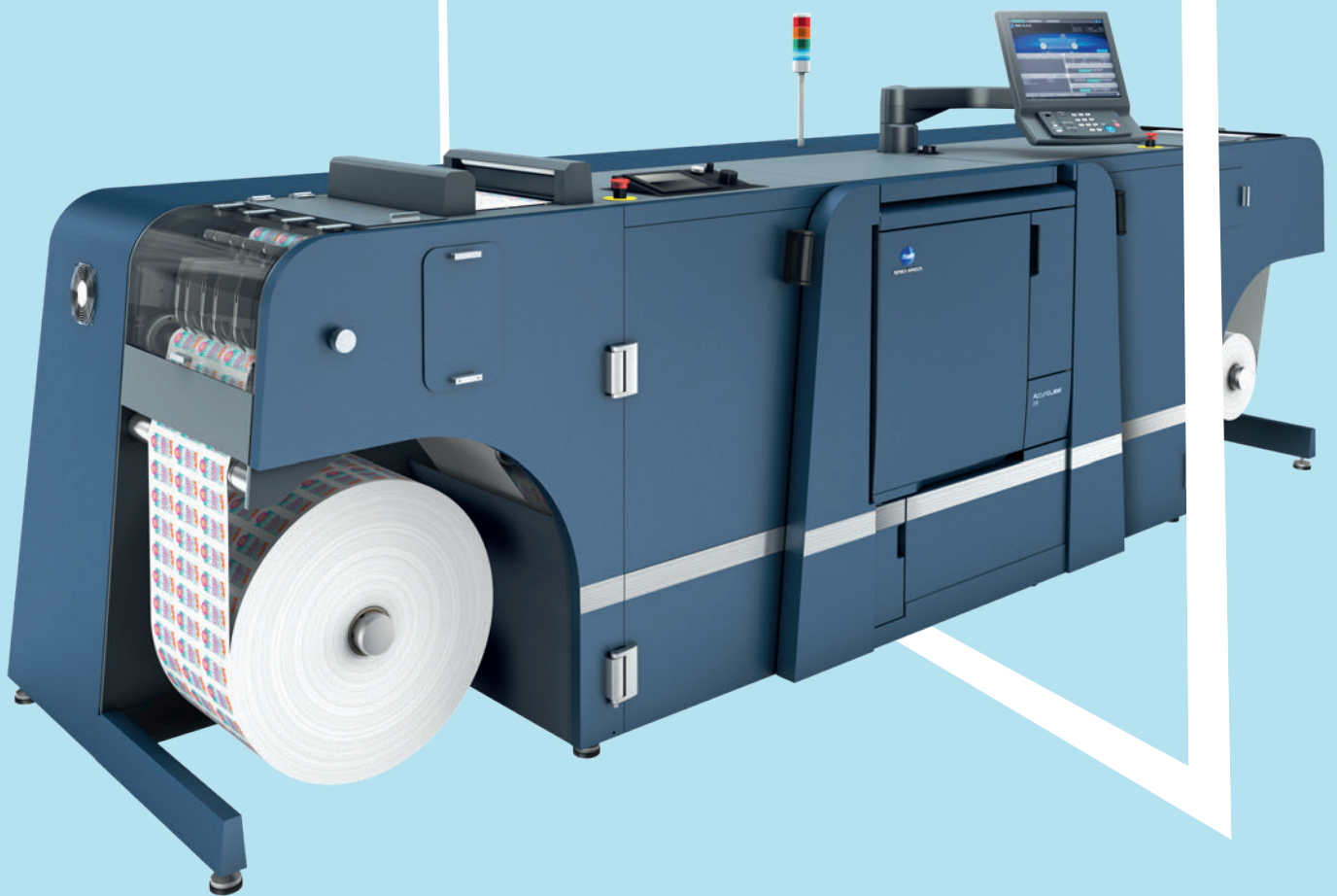

Giving Shape to Ideas

OUTSTANDING PRODUCTIVITY & BRILLIANT IMAGE QUALITY

INTRODUCING THE AccurioLabel 230 FROM KONICA MINOLTA

Label converters and commercial printers face an increasing number of print jobs for small to medium editions, which they are expected to produce in ever-shorter processing times. With conventional flexo and offset printing, it is hardly possible to produce such orders profitably. Meanwhile though, they can be processed easily and efficiently thanks to the flexibility of digital printing.

The AccurioLabel 230 is ideal for professional print providers who want to shift volumes from conventional presses to digital, or are looking for a complementary solution to balance jobs from other digital presses. It is the answer to the reduction of run lengths, shorter delivery times, personalisation and versioning, and to the

production of on-demand print runs. The AccurioLabel 230 offers outstanding productivity, brilliant image quality and surprising ease of use, making it your perfect tool to diversify into new markets and use in conjunction with existing analogue machines.



MARKET TRENDS

GROWTH MARKET: DIGITAL CONTINUES TO CONQUER THE LABEL PRINTING MARKET

The label printing market is considered one of the market segments that will grow in the future. According to recent surveys, more than 25% of new, narrow-web label presses installed worldwide are digital.

In terms of value, label printing market was \$27.72 billion in 2012 and will go to \$45.22 billion by 2022 with 63% growth.

GLOBAL PRINTED LABEL MARKET 2009–2022 DOUBLE MARKET SIZE

Total label printed volume
(Trillion A4 prints)

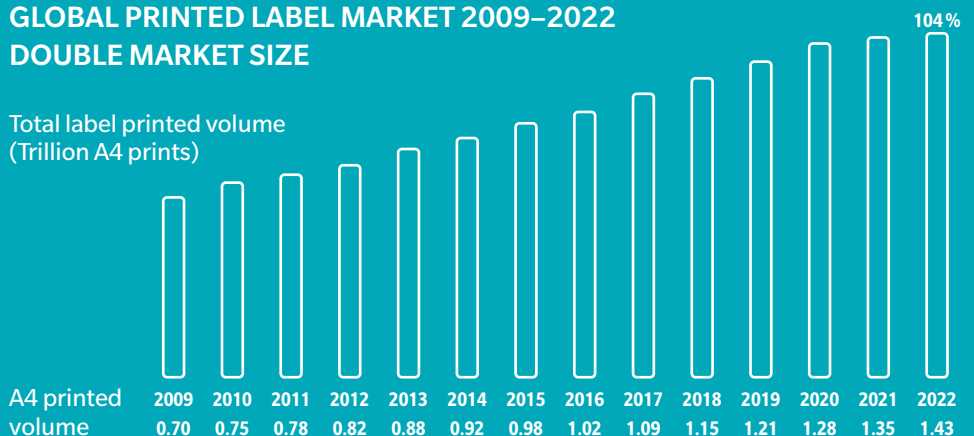

Source: The Future of Label Printing to 2022, Smithers Pira

DIGITAL LABEL PRINTING MARKET SHARE

Source: Investing for growth and profitability WP, Label & Labeling Consultancy, 2016

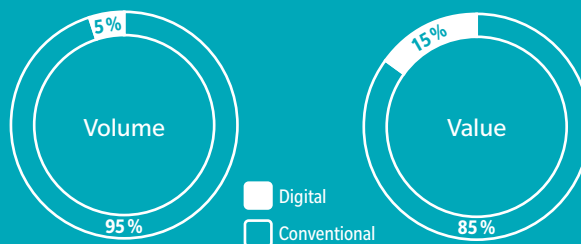

MUCH MORE PROFITABLE THAN CONVENTIONAL PRINTING

The global market for digitally printed labels **grows at more than 15% per year.**

In 2020, **40%** of the worldwide narrow web label press installations will be digital.

50% of label converters have digital machines.

OUTSTANDING QUALITY

Resolution on a Par with Offset

- Excellent resolution of 1,200 dpi x 8 bit produces a high-precision finish

Feeding Speed Detection

- Equipped with a speed detector, AccurioLabel 230 recognises the media feeding speed ensuring highly accurate print registration

Web Cleaning System

- The Web Cleaning System helps to remove any dust or small particles that can affect the print quality

Colour Consistency

- Image density control technology
- Advanced colour management tools

HIGH PRODUCTIVITY

Printing Speed

- AccurioLabel 230 prints at a max. speed of 23.4 m/min
- Most tack papers & films [PP, PET, YUPO] can be printed on at max. speed [120 – 160 µm thickness]

Warm Up Time

- No waiting time between jobs
- Minimises paper waste and improve profitability

Easy Alignment of Paper Web

- AccurioLabel 230 has web guides on both unwinder and rewinder for optimal and accurate feeding of the media

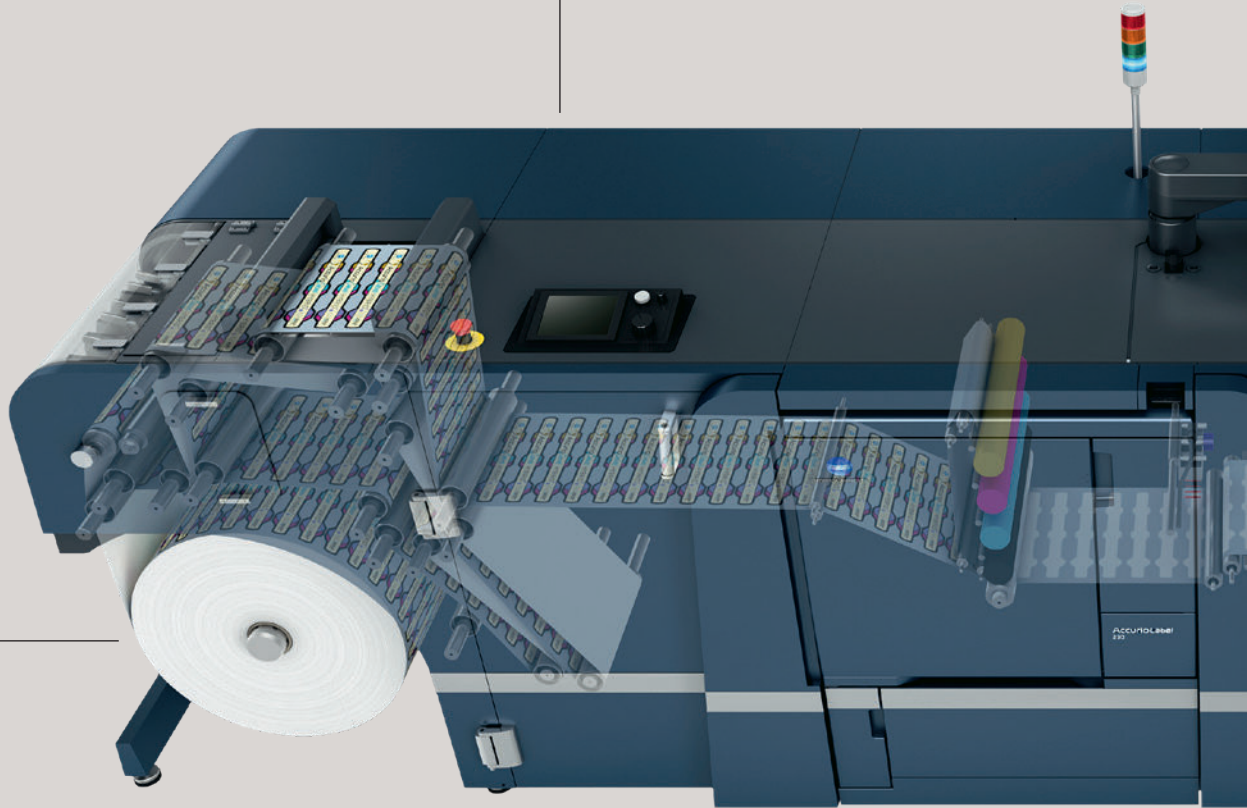

**YOUR ADVANTAGES WITH
THE AccurioLabel 230**
RETHINK LABEL PRINTING

PRINT JOB VARIETY

Overprinting

- With its Overprinting Kit, AccurioLabel 230 can overprint on preprinted media

Two Different Paper Widths

- The AccurioLabel 230 can be adjusted to two different paper widths between 250 and 330 mm by replacing key components

JDF/JMF

- AccurioLabel 230 is JDF/JMF compatible

EASE OF USE

- Maintenance tasks on the AccurioLabel 230 are simple and can be performed in a very short amount of time.
- Tasks that are time-consuming on analogue machines, such as colour adjustments, are quickly and easily performed on this digital press
- Operation is intuitive by following on-screen instructions; no need for extensive user training
- Frees operator time and allows them to perform other tasks

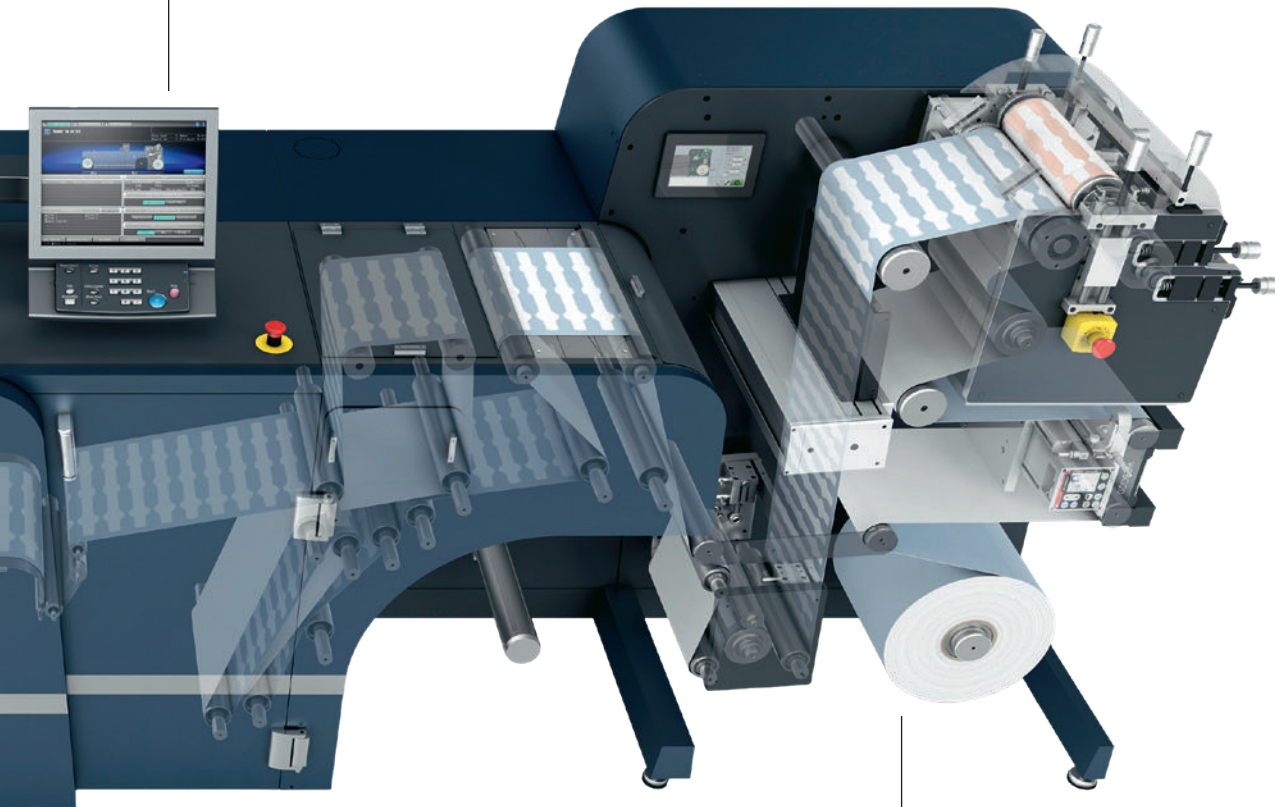

HIGH MEDIA COMPATIBILITY

- No precoating of media necessary
- No special media required

FLEXO PRINTING UNIT

- Optional module for retrofit use
- For printing white or any other color
- Uses standard flexo inks
- Compatible with AccurioLabel 190 and 230
- Registration is done by eye-marks and overprint sensor
- Enables wider range of applications for digital label production

TYPICAL APPLICATIONS

LABEL SUBSTRATES

Glossy or matt adhesive paper, YUPO, PET, PP.
An extended list of supported substrates from the major vendors of self-adhesive media is provided upon purchase of the AccurioLabel 230.



BEVERAGES

Create personalised and unique labels.



FOOD

For short to medium production of local produce.



WINES & SPIRITS

Create wonderful labels for wines and spirits by achieving great quality on untreated textured papers.



COSMETICS

Private label products, ...



HOUSEHOLD

Allows for easy production of different version of the same label.



INDUSTRIAL

For GHS labels, chemical products, identification, ...

AccurioPro Label Impose

RETHINK LABEL PRINTING

AUTOMATED LABEL PRINTING

The AccurioPro Label Impose software provides the perfect solution for optimised media usage, avoiding the possible waste of label substrates. The application gives the operator a simple and intuitive interface to automatically impose and prepare label jobs for printing. In addition, users can also print PDFs as basis for the creation of the required cutting tools or other finishing processes.

AccurioPro Label Impose impresses with its PDF-based workflow and generous feature set, enabling operators to handle many prepress tasks from one central control station. Working seamlessly with the AccurioLabel 230, the software perfectly complements Konica Minolta's label press.

Key benefits

- Automatic creation of label repetitions
- Handling of variable data content
- Adjustable spacing between elements
- Adding standard and custom eye marks
- Gang-up printing of different artwork
- Preparation for die-cutting and finishing tools



AccurioPro
Label Impose

TECHNICAL SPECIFICATIONS

RETHINK LABEL PRINTING

System specifications

Technology	Dry Toner Electrophotography
Resolution	1,200 x 1,200 dpi x 8 bit 1,200 x 3,600 dpi equivalent
Paper widths	250 mm to 330 mm
Max. printed image size	1,195 x 320 mm
Max. printed image width	320 mm
Grammage / substrate thickness	81 to 256 g/m ²
Possible substrates	Paper, YUPO, PP, PET
Feeding speed (printing speed)	23.4 m/min., 18.9 m/min., 13.5 m/min., 9.45 m/min. Speed depends on the paper type (standard speed: 23.4 m/min)
Unit dimensions (W x D x H)	3,869 x 1,141 x 1,478 mm
Unit weight	942 kg
Web control	Integrated web guide system (BST) on unwinder and rewinder
Converting	Capability to connect selected finishing devices

Controller

Internal Konica Minolta Controller	IC-605B
------------------------------------	---------

Flexo Printing Unit

Dimensions (W x D x H)	1,140 x 1,049 x 1,550 mm
Weight	approx. 650 kg

- The support and availability of the listed specifications and functionalities varies depending on operating systems, applications and network protocols as well as network and system configurations.
- The actual life of each consumable will vary depending on use and other printing variables including coverage, size, media type, ambient temperature and humidity.
- Specifications are based on the information available at the time of printing and are subject to change without notice.
- Konica Minolta does not warrant that any specifications mentioned will be error-free.
- All brand and product names may be registered trademarks or trademarks of their respective holders and are hereby acknowledged.

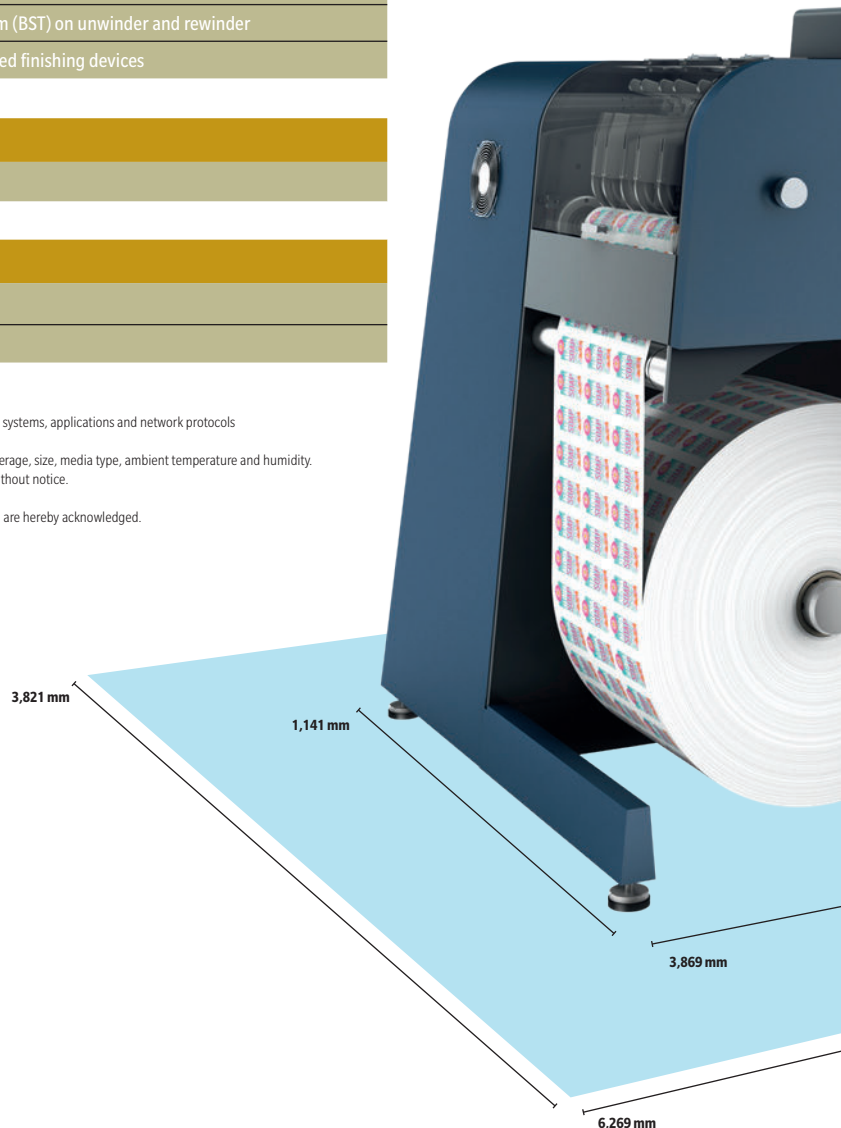



1,478 mm

10 GOOD REASONS

to change from an analogue workflow to digital label printing with the AccurioLabel 230.



1. PERSONALISE YOUR OUTPUT

Konica Minolta's AccurioLabel 230 lets you print variable images and text, fully integrated into your digital workflow. Imagine the many ways in which personalised label printing can help your business.



2. HANDLE MULTIPLE SKUS

Short runs of different labels are easy and quick to run, with no additional prep-time and make-ready. Short-run printing can be more effective and profitable.



3. SHORTEN YOUR LEAD TIMES

With no prepress setup time, personalised labels can start printing without delay.



4. LOWER YOUR COSTS

Think about it: Less waste, zero plates used, minimal labour requirements – it all adds up to lower running costs and increased profitability.



5. MINIMAL FOOTPRINT

The AccurioLabel 230 is a compact digital label press with just 12' separating the unwinder and the rewinder, allowing it to fit into the tightest of spaces on your production floor.



6. IMPROVE CONSISTENCY

Complete colour management control ensures consistency across the substrate from the beginning to the end of your entire press run.



7. SIMPLIFY YOUR OPERATION

Digital control is far simpler than that of conventional analogue systems – and you can queue jobs right from your touch screen control panel, making reprints faster and more cost-effective.



8. COMPLEMENTARY TO YOUR EXISTING PRESSES

The AccurioLabel 230 perfectly complements your analogue and digital production flow, allowing you to shift short runs from analogue to digital, as well as perform load balancing of digitally produced jobs.



9. QUICK AND EASY EXCHANGE OF MEDIA ROLLS

Substrates can be switched simply by splicing one substrate onto the other. All settings are stored in the print engine controller.



10. GET ON THE INSIDE TRACK OF INNOVATION

Partnering with Konica Minolta leverages the power of our cutting-edge innovations in digital production, backed by 100 years of leadership in optical and print technology.



PROKOM – CONNECT WITH INDUSTRY CONSULTANTS

RETHINK LABEL PRINTING

AND GAIN VALUABLE INSIGHT

Konica Minolta is a proud supporter of the independent user association PROKOM, who offers its members the ability to connect with industry consultants and gain valuable insights.

Structured learning programs support all elements of your company's business. From business planning through sales and marketing advice, you will have the opportunity to link in with the PROKOM team, connecting you with companies across both Europe and North America.



prokom

For more details please visit: www.prokom.org

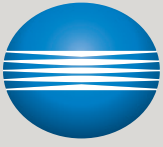

KONICA MINOLTA